

# General Hardware



We take the worry out of  
protecting what's valuable to you.  
Lockwood: *no worries*<sup>®</sup>

**LOCKWOOD**

**ASSA ABLOY**

**25YEAR**

**MECHANICAL  
WARRANTY**

[www.lockweb.com.au](http://www.lockweb.com.au)

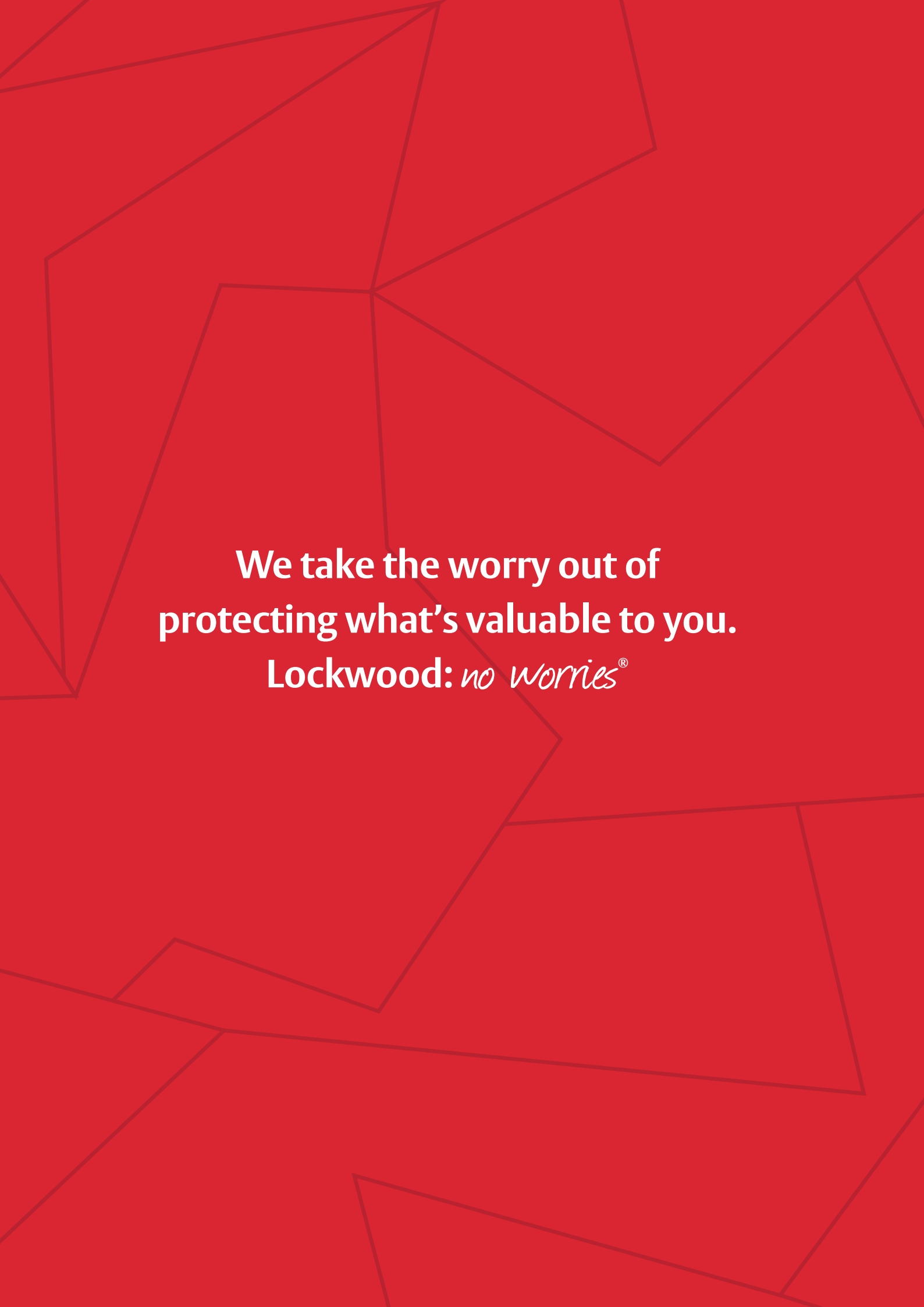

**We take the worry out of  
protecting what's valuable to you.**  
**Lockwood: *no worries*<sup>®</sup>**

# Contents



Braille Signage

page 4



Hooks and Brackets

page 8



Hinges

page 12

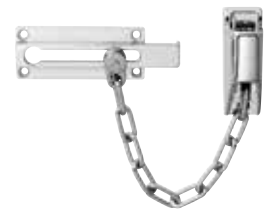

Door Chain Locks

page 19



Door Stops

page 21



Security Door Viewer

page 28



Bolts and Latches

page 29



Flush Pulls

page 35



Cupboard Handles

page 39



Window Accessories

page 42

# Braille Signage



Lockwood Braille Signage is designed in Australia to meet requirements for Braille and tactile signage applications.

## Braille Signage

Each plate consists of embossed tactile design, English text and braille lettering. The embossed components use standard imagery and fonts to ensure vision impaired non-braille readers can decipher the sign.

The standard braille locator symbol is on the left hand side of the plate in line with the braille elements.

Braille elements are embossed, not engraved, glued on or made of individual components which can be separated from the sign surface.

## Style and Variety

The Lockwood range of Braille and tactile signs are available in seven designs to suit a range of applications. Available designs are:

- Male
- Female
- Unisex
- Unisex Disabled Access Left Hand Transfer
- Unisex Disabled Access Right Hand Transfer
- Female Ambulant
- Male Ambulant

## Product Details

### Dimensions

The Lockwood Braille Signage is 220mm x 170mm making them the ideal complement to Lockwood 200 Series and 202 Series Artefact Furniture. Sign corners and all embossed elements incorporate rounded corners to ensure a positive tactile experience.

### Finish

Lockwood Braille Signage is supplied with white tactile elements on a blue background allowing for luminous contrast.

### Materials

Lockwood Braille Signage is made from robust and durable ABS plastic enabling for single piece construction to resist picking and/or adhesive failure. This also provides a continuous, bleach resistant sign surface for ease of cleaning and subsequent improved hygiene.

### Mounting

Fixing Lockwood Braille Signage couldn't be easier as each plate is supplied with a single piece adhesive backing enabling simple "peel-off and stick" mounting. Signs should not be located on the door itself but rather on the wall adjacent to the door on the latch side, a minimum of 50mm from the frame. The tactile and Braille components of the signs should be positioned between 1200mm and 1600mm from the floor.

# Braille Signage

## Braille Signage Male

Dimensions	Part Number
220mm x 170mm	BRS1700



## Braille Signage Female

Dimensions	Part Number
220mm x 170mm	BRS1701



## Braille Signage Unisex

Dimensions	Part Number
220mm x 170mm	BRS1703



## Braille Signage Unisex Disabled Access Left Hand Transfer

Dimensions	Part Number
220mm x 170mm	BRS1706L



# Braille Signage

## Braille Signage Unisex Disabled Access Right Hand Transfer

Dimensions	Part Number
220mm x 170mm	BRS1760R



## Braille Signage Female Ambulant

Dimensions	Part Number
220mm x 170mm	BRS1707F



## Braille Signage Male Ambulant

Dimensions	Part Number
220mm x 170mm	BRS1707M



# Braille Signage

## Ordering Procedure

Sample part number BRS1700 is made up of two sections. Choose your product by selecting an option from each section.

Product Code	Design
BRS17	00

Product Code	
Braille Signage	BRS17

Design	
Male	00
Female	01
Unisex	03
Unisex Disabled Access Left Hand Transfer	06L
Unisex Disabled Access Right Hand Transfer	06R
Female Ambulant	07F
Male Ambulant	07M

# Hooks and Brackets



The Lockwood range of Hooks and Brackets provide solutions for numerous applications including storage of coats, hats and robes, securing doors and supporting handrails

## Applications

The Lockwood range of Hooks and Brackets are typically installed on timber substrates as wood screws are supplied as standard.

### Product Details

<b>Cabin Hooks</b>	Cast brass hook and eye, three lengths, fixing screws included.
<b>Hat and Coat Hooks</b>	Cast zinc and stainless steel, 6 styles, fixing screws included.
<b>Robe Hooks</b>	Cast Zinc, fixing screws included.
<b>Handrail Bracket</b>	Cast Zinc, fixing screws included.
<b>Finishes</b>	Chrome (CP) Satin (SP) Satin Stainless Steel (SSS)
<b>Materials</b>	Zinc Brass Stainless Steel

### Standards and Compliance



These products have been successfully tested in accordance with AS 2331-3.1: 2001. Neutral Salt Spray Test (NSS TEST).



# Hooks and Brackets

## Cabin Hook

Length	Finish	Packaging	Part Number
75mm	Chrome Plate	Display	L829-75MCPDP
100mm	Chrome Plate	Display	L829-100MCPDP
150mm	Chrome Plate	Display	L829-150MCPDP

### Features and Specifications

- Cast brass hook and eye
- Available in three lengths
- Individually display packed
- Complete with fixing screws



## L45 Hat and Coat Hook

Finish	Packaging	Part Number
Chrome Plate	Display	L45CPDP
Satin Chrome Pearl	Display	L45SPDP

### Features and Specifications

- Zinc alloy castings
- Individually display packed
- Complete with fixing screws



## L432 Door Bumper and Hook

Finish	Packaging	Part Number
Chrome Plate	Display	L432CPDP
Satin Chrome Pearl	Display	L432SPDP

### Features and Specifications

- Zinc alloy castings with nylon cushion tip
- Individually display packed
- Complete with fixing screws



## L1310 Combined Hat and Coat Hook

Finish	Packaging	Part Number
Chrome Plate	Display	L1310CPDP
Satin Chrome Pearl	Display	L1310SPDP

### Features and Specifications

- Zinc alloy castings
- Individually display packed
- Complete with fixing screws



# Hooks and Brackets

## L1320 Combined Hat and Coat Hook

Finish	Packaging	Part Number
Chrome Plate	Display	L1320CPDP
Satin Chrome Pearl	Display	L1320SPDP

### Features and Specifications

- Zinc alloy castings
- Individually display packed
- Complete with fixing screws



## 296 Hat and Coat Hook

Finish	Packaging	Part Number
Satin Stainless Steel	Trade	296SSS

### Features and Specifications

- Stainless steel
- Individually display packed
- Complete with fixing screws



## 297 Bumper and Hook

Finish	Packaging	Part Number
Satin Stainless Steel	Trade	297SSS

### Features and Specifications

- Stainless steel
- Individually display packed
- Complete with fixing screws



# Hooks and Brackets

## L94 Robe Hook

Finish	Packaging	Part Number
Chrome Plate	Display	L94CPDP
Satin Chrome Pearl	Display	L94SPDP

### Features and Specifications

- Zinc alloy castings
- Individually display packed
- Complete with fixing screws



## Handrail Bracket

Finish	Packaging	Part Number
Satin Chrome Pearl	Display	L832SPDP

### Features and Specifications

- Zinc alloy castings
- Individually display packed
- Complete with fixing screws



# Hinges



## General Information

The 100 Series Architectural Hinges are designed to provide an effective solution to hanging doors where there is a need for high grade, architectural quality hinges. These hinges are suitable for use on aluminium or steel glazed doors and solid core timber doors. Many of them can also be used on fire doors.

## Lockwood Warranty

Selection of the appropriate hinge for the application is critical to ensure the longevity of the hinge and customer satisfaction. The Lockwood warranty is only applicable for hinges that are installed in accordance with the recommendations of the hinge selection table on page 15.

## Hinge Height and Width

When reading dimensions, the first figure always indicates the hinge height and the second indicates the width, eg. 100 mm x 75 mm. The door thickness and door jamb width (also trim size if applicable) determine the width of the hinge required. The width is measured across the leaves when the hinge is fully opened as shown in Diagram 1.

## Security

Fixed pin hinges should be used on exterior doors or doors opening out. Also, doors made of particle should have a capped tongue edge strip framing the door, so that hinges can be screwed into solid material.

## Hinge Maintenance

The maintenance free hinges in the Lockwood 100 Series Architectural Hinge range are the Severe Duty Butt Hinges with the phosphorous bronze bushes (Part numbers LW10000SDSSS and LW10075SDSSS). These Severe Duty Butt Hinges are self-lubricating.

The remainder of the Lockwood 100 Series Architectural Hinge range are greased hinges which are fit for purpose in many applications. The grease is fundamental to the durability of the product. However, with use it is possible for some grease to seep out onto the surface of the hinge and if left unchecked can lead to door, frame, wall or floor staining in extreme cases.

To prevent this from happening, greased hinges should be monitored and cleaned externally during their life.

In environments where hygiene is critical such as hospitals and food facilities or where hinge maintenance is not a priority, the Lockwood Severe Duty Butt Hinges are highly recommended.

## Finishes

Satin Stainless Steel **SSS**  
Polished Stainless Steel **PSS**  
Satin Chrome **SC**

## Number of Hinges Per Door

For doors up to 2,100mm high, at least 3 hinges

should be used if the Adjusted Door Weight is over 20kg. If the Adjusted Door Weight is 20kg or less, 2 hinges can be used. For doors over 2,100mm high, at least 4 hinges should be used. The method for establishing the Adjusted Door Weight is given on Page 13.

## Fire Rated

Please refer to the Hinge Selection Table on page 13 for hinge fire rating information.

## Door Stops

It is recommended a door stop be installed to ensure that the door has a positive backstop at the degree of opening selected. It is essential to use a door stop where design factors of the building necessitate opening out of external doors and no windbreak is provided.

## Hinge Selection

Prior to selecting a suitable hinge, the Adjusted Door Weight needs to be calculated. The Adjusted Door Weight takes into account the extra stresses that door closers and wider doors place on the hinges and is used to select the appropriate hinge from the table below. Please refer to Page 15 for calculation of the Adjusted Door Weight.

# Hinges

## Calculating the Adjusted Door Weight.

Establish the weight of door including all door furniture, metal plates and windows. If you have a door closer, add 20% to the door weight.

If the door closer has back-check, add 75% to the door weight, instead of the 20% above.

For door width over 950mm:

951mm to 1050mm, add 10% to door weight.

1051mm to 1150mm, add 20% to door weight.

1151mm to 1250mm, add 30% to door weight.

Therefore, Adjusted Door Weight = (total weight of the door) + (% for door closer/back-check) + (% for any width over 950mm) Please refer to [lockweb.com.au/hinge-calc](http://lockweb.com.au/hinge-calc) for the online Hinge Adjusted Weight Calculator.

## Hinge Selection Table

This Hinge Selection Table has been developed to assist in hinge selection for doors in commercial applications where frequent use is anticipated (eg hospitals, schools, universities, offices and public buildings). In applications where it is reasonable to anticipate less frequent use (eg

apartment entry doors) the maximum adjusted door weight becomes less relevant and as such the complete range of Lockwood hinges can be relied on to provide trouble free service.

Hinge Part Number	Hinge Size (mm)	Description	*Finish	Type	*Material	Maximum Adjusted Door Weight (kg)	Fire Rating				
LW10075RLSSS	100x75x2.5	Right Hand Lift Off	SSS	Lift Off Hinge	SS	50	None				
LW10075LLSSS		Left Hand Lift Off									
LW10000BBPSS	100x100x2.5	Ball Bearing	PSS	Butt Hinge	SS	60	These Lockwood hinges have been successfully tested up to four hours (depending on type of doorset) on fire door assemblies in accordance with Australian Standard AS 1905.1-2005, Part 1: Fire Resistant Doorsets.				
LW10000BBS	100x100x2.5	Ball Bearing	SSS								
LW10075BBPSS	100x75x2.5	Ball Bearing	PSS								
LW10075BBS	100x75x2.5	Ball Bearing	SSS								
LW10000FPPSS	100x100x2.5	Fixed Pin	PSS								
LW10000FPSS	100x100x2.5	Fixed Pin	SSS								
LW10075FPPSS	100x75x2.5	Fixed Pin	PSS								
LW10075FPSS	100x75x2.5	Fixed Pin	SSS								
LW10000LPPSS	100x100x2.5	Loose Pin	PSS								
LW10000LPSS	100x100x2.5	Loose Pin	SSS								
LW10075LPPSS	100x75x2.5	Loose Pin	PSS								
LW10075LPSS	100x75x2.5	Loose Pin	SSS								
LW10000BBSC	100x100x2.5	Ball Bearing	SC					Butt Hinge	MS	60	These Lockwood hinges have been successfully tested up to four hours (depending on type of doorset) on fire door assemblies in accordance with Australian Standard AS 1905.1-2005, Part 1: Fire Resistant Doorsets.
LW10075BBSC	100x75x2.5	Ball Bearing									
LW10000FPSC	100x100x2.5	Fixed Pin									
LW10000LPSC	100x100x2.5	Loose Pin									
LW10075LPSC	100x75x2.5	Loose Pin									
LW10000BBHDSS	100x100x3.0	Heavy Duty	SSS	Heavy Duty Butt Hinge	SS	70					
LW10000SDSS	100x100x3.0	Severe Duty	SSS	Severe Duty Butt Hinge	SS	120	These Lockwood hinges have been successfully tested up to four hours (depending on type of doorset) on fire door assemblies in accordance with Australian Standard AS 1905.1-2005, Part 1: Fire Resistant Doorsets.				
LW10075SDSS	100x75x3.0										

\*Legend: SS=Stainless Steel

MS=Mild Steel

SSS=Satin Stainless Steel finish

PSS=Polished Stainless Steel finish

SC=Satin Chrome finish

# Hinges

## Typical Applications

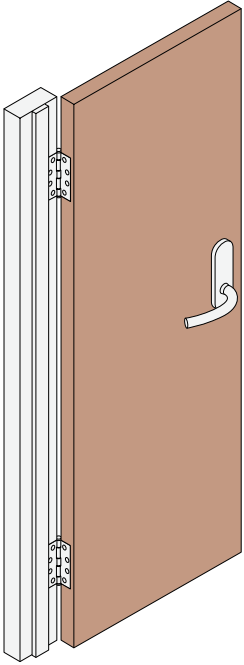

Typical internal doors

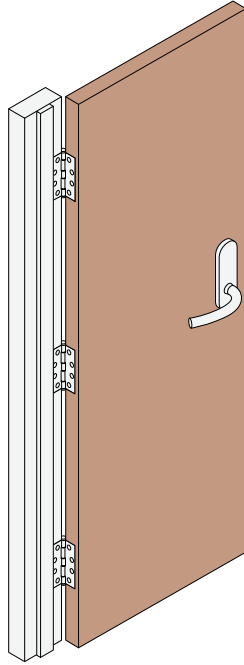

Typical external or high usage doors

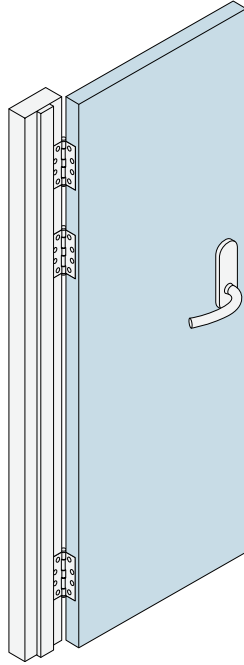

Typical heavy doors

## Hinge Throw Selection

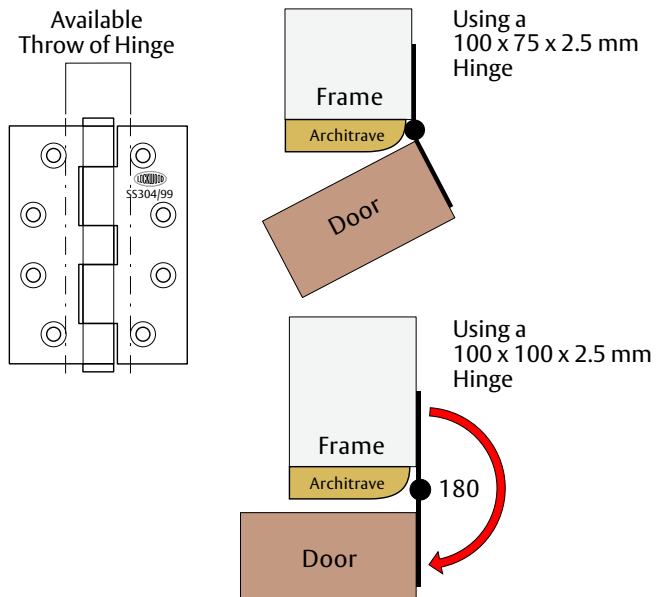

## Diagram 1

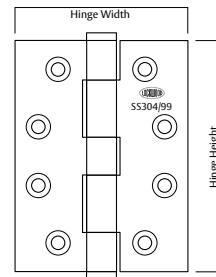

# Hinges

## Stainless Steel Ball Bearing Hinges

### Satin Stainless Steel/Polished Stainless Steel/Button Tipped Hinge

Suitable for interior/exterior doors where a durable, architectural ball bearing hinge is required, or when being used in conjunction with a door closer.

- Two ball bearings
- Manufactured from 304 stainless steel
- Available fixed pin only
- Metric sizes
- Standard metric hole pattern

**Sizes:** 100 x 75 x 2.5 mm,  
100 x 100 x 2.5 mm  
and 100 x 100 x 3.0mm

**Thickness:** 2.5 mm and 3.0mm

**Screws:** Stainless Steel Screws  
supplied with each hinge 10  
Gauge x 30mm Wood Screws  
x 8 M5 12mm Metal Thread  
Screws x 4

**Pack Size:** 30 (and 18 for the 3.0mm  
thick hinge)

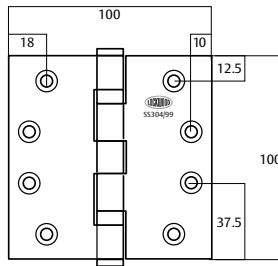
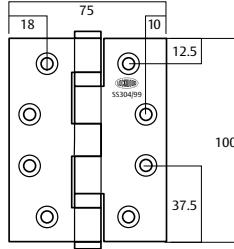

LW10075BBPSS



LW10075BBSSS



## Stainless Steel Hinges

### Satin Stainless Steel/Polished Stainless Steel/Button Tipped Hinge

Suitable for interior/exterior doors where a durable, architectural hinge is required.

- Manufactured from 304 stainless steel
- Available fixed and loose pin
- Metric sizes
- Standard metric hole pattern

**Sizes:** 100 x 75 x 2.5 mm  
and 100 x 100 x 2.5 mm

**Thickness:** 2.5 mm

**Screws:** Stainless Steel Screws  
supplied with each hinge  
10 Gauge x 30mm Wood  
Screws x 8 M5 x 12mm Metal  
Thread Screws x 4

**Pack Size:** 30

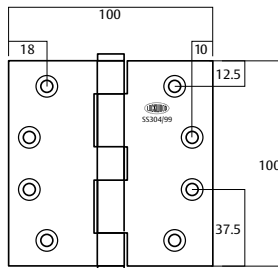
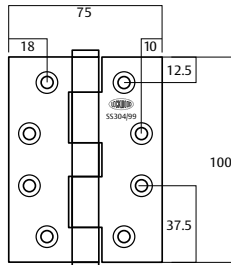

LW10075LPSSS



LW10000FPPSS



# Hinges

## Mild Steel Ball Bearing Hinges

Suitable for general purpose interior/ exterior doors where a standard ball bearing hinge is required or when being used in conjunction with a door closer.

- Manufactured from high grade steel
- Available fixed pin only
- Metric sizes
- Standard metric hole pattern

**Sizes:** 100 x 75 x 2.5 mm  
and 100 x 100 x 2.5 mm

**Thickness:** 2.5 mm

**Screws:** Zinc Plated Mild Steel Screws  
supplied with each hinge  
10 Gauge x 30mm Wood  
Screws x 8 M5 x 12mm Metal  
Thread Screws x 4

**Pack Size:** 30

**Finish:** Satin Chrome

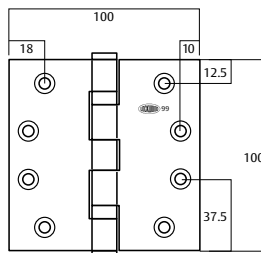
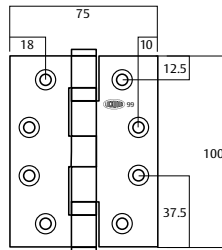

LW10000BBSC



## Mild Steel Hinges

Suitable for general purpose interior/ exterior doors where a standard hinge is required.

- Manufactured from high grade steel
- Available fixed and loose pin
- Metric sizes
- Standard metric hole pattern

**Sizes:** 100 x 75 x 2.5 mm  
and 100 x 100 x 2.5 mm

**Thickness:** 2.5 mm

**Screws:** Zinc Plated Mild Steel Screws  
supplied with each hinge  
10 Gauge x 30mm Wood  
Screws x 8 M5 x 12mm Metal  
Thread Screws x 4

**Pack Size:** 30

**Finish:** Satin Chrome

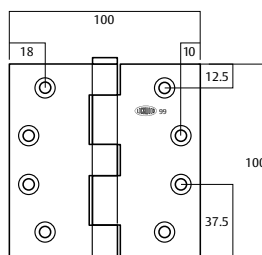
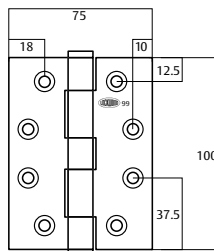

LW10000LPSC





# Hinges

## Stainless Steel Bushed Bearing Hinges (Severe Duty)

High performance bushed bearing butt hinges suitable for severe duty applications.

- Manufactured from 304 stainless steel
- Available in fixed pin only
- Metric sizes

**Sizes:** 100 x 100 x 3.0mm  
and 100 x 75 x 3.0mm

**Screws:** Stainless Steel Screws supplied with each hinge. 10 Gauge x 30mm Wood Screws x 8  
M5 x 14mm Metal Thread Screws x 4

**Pack Size:** 36

**Finish:** Satin Stainless Steel

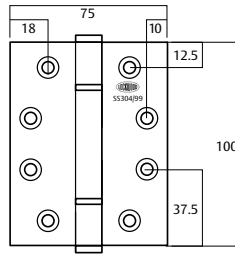

LW10075SDSSS

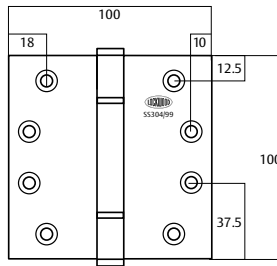

## Lift Off Stainless Steel Hinges

Suitable for where a door may need to be lifted off after installation

- Available in left and right hand versions
- Manufactured from 304 stainless steel
- Metric sizes

**Sizes:** 100 x 75 x 2.5mm

**Screws:** Stainless Steel Screws supplied with each hinge. 10 Gauge x 30mm Wood Screws x 8  
M5 x 12mm Metal Thread Screws x 4

**Pack Size:** 30

**Finish:** Satin Stainless Steel

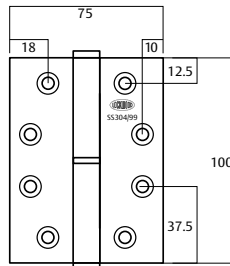

LW10075LLSSS



# Hinges

## Fast Fix Stainless Steel Ball Bearing Hinge

Ideal for general purpose interior/ exterior use where aluminium frames/ doors are used.

- Two ball bearings
- Manufactured from 304 stainless steel
- Available fixed pin only
- Metric sizes

**Sizes:** 100 x 70 x 2.5 mm

**Thickness:** 2.5 mm

**Screws:** Stainless Steel Screws supplied with each hinge  
 10 Gauge x 30mm Wood Screws x 6  
 M5 x 12mm Metal Thread Screws x 6

**Pack Size:** 30

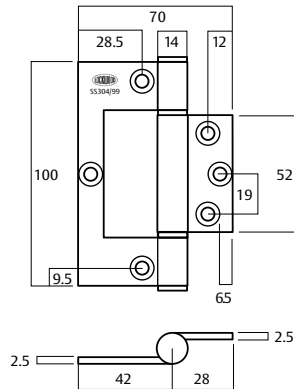

LW10070BBFFSS



## Fast Fix Stainless Steel Ball Bearing Hinge

Ideal for general purpose interior/ exterior use where timber frames/ doors are used.

- Two ball bearings
- Manufactured from 304 stainless steel
- Available fixed pin only
- Metric sizes

**Sizes:** 100 x 70 x 2.5 mm

**Thickness:** 2.5 mm

**Screws:** Stainless Steel Screws supplied with each hinge  
 10 Gauge x 32mm Wood Screws x 7  
 M5 x 12mm Metal Thread Screws x 7

**Pack Size:** 30

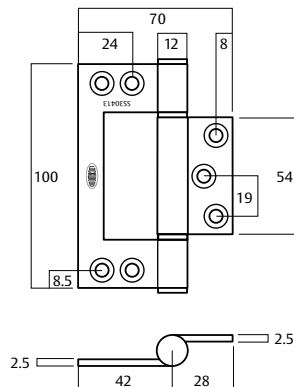

LW10070BBFFSSA

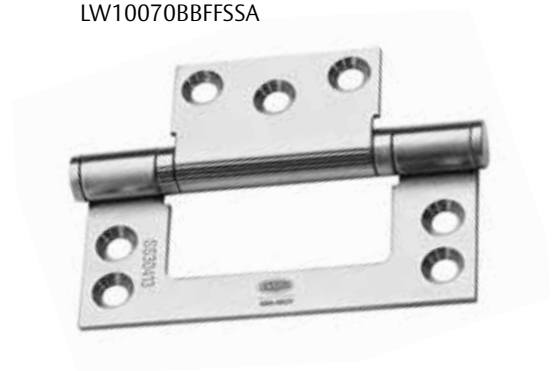

# Door Chains and Locks



The Lockwood range of Door Chains and Locks are an easily fitted security device used for added home protection. The Lockwood Door Chains and Locks can only be used on the inside of the door. The Lockwood Door Chains and Locks are not accessible from the outside.

## Applications

The Lockwood range of Door Chains and Locks are typically installed on the internal side timber doors as wood screws are supplied as standard.

### Product Details

<b>Door Thickness</b>	Any
<b>Finishes</b>	Chrome Plate (CP)
<b>Materials</b>	Cast Zinc Hardened Steel
<b>Fixing</b>	Fixing screws included

### Standards and Compliance



These products have been successfully tested in accordance with AS 2331-3.1: 2001. Neutral Salt Spray Test (NSS TEST).

# Door Chains and Locks

## 140 Door Chain Lock - Key Operated

Finish	Packaging	Part Number
Chrome Plate	Display	140CPDP

Provides the security of a door chain plus the convenience of entry from outside by key.

### Features and Specifications

#### Housing and Slide

Diecast zinc

#### Chain

Hardened steel

#### Mechanism

5 disc tumbler

#### Keying

Individually keyed

#### Packaging

Individually display packed, complete with fixing screws.

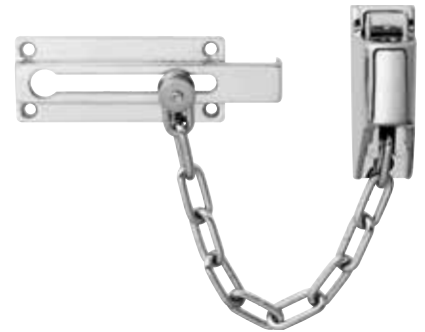

## 150 Door - Chain and Bolt

Finish	Packaging	Part Number
Chrome Plate	Display	150CPDP

A strong, secure combination of door chain and bolt.

### Features and Specifications

#### Housing and Strike

Diecast zinc

#### Chain

Hardened steel

#### Bolt

Hardened steel

#### Packaging

Individually display packed, complete with fixing screws.



# Door Stops



The range of Lockwood Door Stops provide numerous solutions for ensuring that door travel is contained within the required specification. Walls are protected from furniture impacts and doors can be held open at any desired position.

## Applications

The range of Lockwood Door Stops are able to be mounted on numerous situations in many positions including floors and walls.

## Product Details

### Finishes

Chrome Plate (CP)  
Satin Chrome (SC)  
Satin Pearl (SP)  
Polished Stainless (PS)  
Satin Stainless (SS)  
Powder Coat (BLK/PPC)

### Materials

Stainless Steel  
Zinc  
Brass  
Rubber

## Standards and Compliance



These products have been successfully tested in accordance with AS 2331-3.1: 2001. Neutral Salt Spray Test (NSS TEST).

# Door Stops

## A250 Door Stop

Finish	Packaging	Part Number
Chrome Plate	Trade	A250CP
Satin Chrome	Trade	A250SC

The 250 is a floor mounted door stop of quality design, finish and appearance. The resilient rubber buffer provides excellent protection for door finishes.

### Features and Specifications

#### Dimensions

50 mm high with a triangular base 50 mm wide and 60 mm deep.

#### Materials

Body - Stainless Steel

Buffer - Rubber

#### Fixing

Mounting screws included

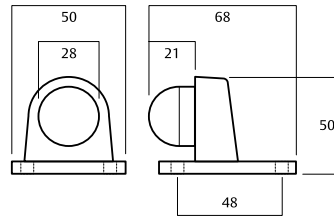

## A280 Round Door Stop

Finish	Packaging	Part Number
Satin Stainless	Trade	A280SS
Polished Stainless	Trade	A280PS

This general purpose door stop is floor mounted and prevents doors and handles damaging walls and fixtures. The black rubber buffer provides further protection for door finishes.

### Features and Specifications

#### Dimensions

35 mm diameter.

#### Materials

Body - Stainless Steel

Buffer - Rubber

#### Fixing

Mounting screw included

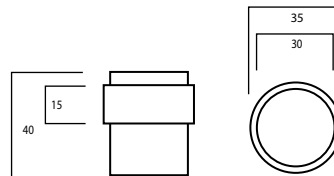

# Door Stops

## A290 Half Moon Door Stop

Finish	Packaging	Part Number
Satin Chrome Brushed	Trade	A290SC

Designed to be floor mounted, the door stop prevents doors and handles damaging walls and fixtures. The black rubber buffer gives further protection for door finishes.

### Features and Specifications

#### Dimensions

43 mm diameter.

#### Materials

Body - Zinc

Buffer - Rubber

#### Fixing

Mounting screw included

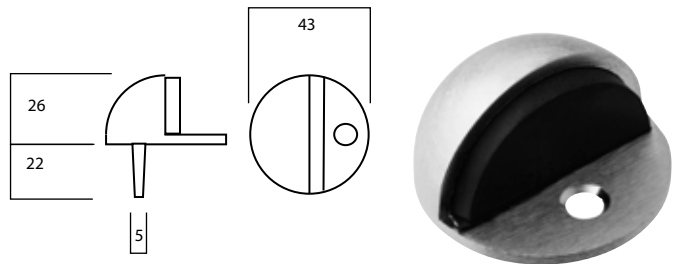

## A292 Half Moon Door Stop Packer

Finish	Packaging	Part Number
Satin Chrome Brushed	Trade	A292SC

10mm packer to suit A290 half moon door stop.

### Features and Specifications

#### Dimensions

43 mm diameter.

10mm thick packer

#### Materials

Body - Zinc

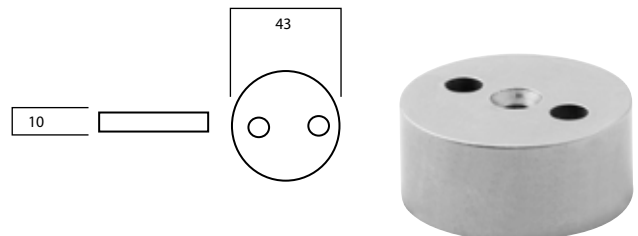

# Door Stops

## A300 Door Stop

Finish	Packaging	Part Number
Satin Stainless Steel	Trade	A300SS
Polished Stainless Steel	Trade	A300PS

Designed to be wall mounted, the door stop prevents doors and handles damaging walls and fixtures. The 300 Series door stops feature concealed fixing behind the rubber buffer.

### Features and Specifications

#### Dimensions

75mm projection  
19mm diameter

#### Materials

Body - Stainless Steel  
Buffer - Rubber

#### Fixing

Mounting screw included

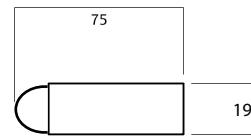

## A310 Magnetic Door Stop

Finish	Packaging	Part Number
Satin Chrome Brushed	Trade	A310SC

Designed to be wall or floor mounted, this door stop incorporates a magnetic catch to hold the door in the open position.

### Features and Specifications

#### Materials

Body - Zinc

#### Fixing

Mounting screws included

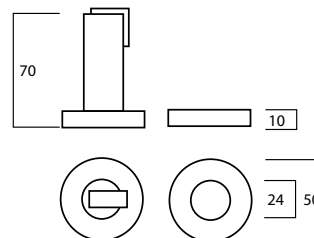



# Door Stops

## A320 Door Stop

Finish	Packaging	Part Number
Satin Chrome	Trade	A320SC
Polished Chrome	Trade	A320CP

Designed to be wall mounted, the door stop prevents doors and handles damaging walls and fixtures. The black rubber buffer gives further protection for door finishes.

### Features and Specifications

#### Dimensions

38mm diameter base.  
75mm projection.

#### Materials

Body - Zinc  
Buffer - Rubber

#### Fixing

Mounting screws included

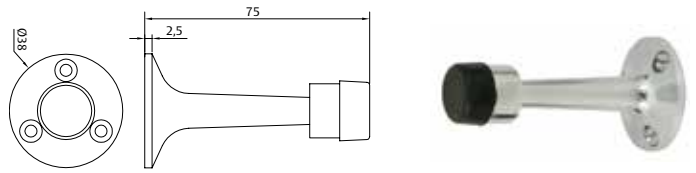

## A330 Door Stop

Finish	Packaging	Part Number
Satin Stainless Steel	Trade	A330SS
Polished Stainless Steel	Trade	A330PS

Designed to be wall mounted, the door stop prevents doors and handles damaging walls and fixtures. The black rubber buffer gives further protection for door finishes.

### Features and Specifications

#### Dimensions

80mm projection.  
19mm width.

#### Materials

Body - Stainless Steel  
Buffer - Rubber

#### Fixing

Mounting screw included

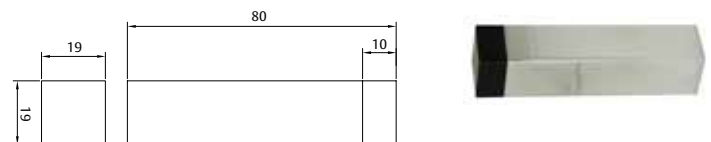

# Door Stops

## A350 Door Stop

Finish	Packaging	Part Number
Chrome Plate	Trade	A350CP
Satin Chrome	Trade	A350SC

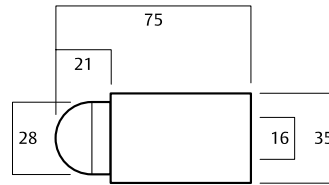

Designed to be wall mounted, the door stop prevents doors and handles damaging walls and fixtures. The 350 Series door stops feature concealed fixing behind the rubber buffer.

### Features and Specifications

#### Dimensions

75mm projection  
35mm diameter

#### Materials

Body - Zinc  
Buffer - Rubber

#### Fixing

Mounting screw supplied

## 857 Door Stop

Finish	Packaging	Part Number
Satin Chrome Pearl	Trade	857SP

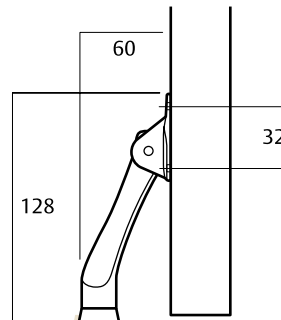

A coil spring and ball ensure the arm indexes at "out of way" position. Designed for use as a bottom rail door stop.

### Features and Specifications

#### Materials

Body and arm – cast brass  
Buffer – rubber

#### Fixing

Mounting screw supplied

# Door Stops

## 2307 Door Stop

Finish	Packaging	Part Number
Black	Trade	2307BLK
Specify Colour	Trade	2307PPC

This doorstop is designed to cushion the high impact of sliding doors and windows. With a secure durable design, it will prevent collision damage.

### Features and Specifications

#### Materials

Body - Zinc

Buffer - Rubber

#### Fixing

Mounting screws not included



## 2308 Door Stop with Cover

Finish	Packaging	Part Number
Satin Pearl	Trade	2308SP
Specify Colour	Trade	2308PPC

This doorstop is designed to cushion the high impact of sliding doors and windows. With a secure durable design, it will prevent collision damage.

### Features and Specifications

#### Materials

Body - Zinc

Buffer - Rubber

#### Fixing

Mounting screws not included



# Security Door Viewer



The Lockwood Security Door Viewer is constructed from solid brass and comes plated in two finishes. It features an optical glass lens providing a clear 160° angle of view. It is suited to door thicknesses of 33mm to 50mm.

## Security Door Viewer - Glass Lens

Finish	Packaging	Part Number	Body	Door Thickness
Chrome	Display	160CPDP	Brass	33 to 50mm
Polished Brass	Display	160PBDP	Brass	33 to 50mm

### Fire Rated

The 160 Security Door Viewer has a glass lens and has been tested up to 4 hours on fire door assemblies in accordance with Australian Standard AS 1905.1: Fire Resistant Doorsets.

# Bolts and Latches



The range of Lockwood Bolts and Latches offer a comprehensive range of quality products that compliment the range of existing Lockwood furniture.

## Application

The range of Lockwood Bolts and Latches are suitable for a wide range of applications for both internal and external doors with pull handles, through fix door furniture, disabled and emergency turns.

## Product Details

<b>Door Thickness</b>	Any
<b>Finishes</b>	Chrome Plate (CP) Satin Chrome (SC) Satin Chrome Pearl (SP) Polished Stainless Steel (PSS) Satin Stainless Steel (SSS) Polished Brass (PB)

## Standards and Compliance



These products have been successfully tested in accordance with AS 2331-3.1: 2001. Neutral Salt Spray Test (NSS TEST).

# Bolts and Latches

## 7580 Roller Bolt

Finish	Packaging	Part Number
Satin Chrome face plate and T strike	Trade	7580SC

Designed for both internal and external doors, the Lockwood Roller Bolt is suited to a wide range of applications and perfectly complements the Paradigm deadbolt range and Lockwood Entrance handles. The roller bolt functions to “snap” in and out of the strike which will keep the door closed when it isn't locked. This means a lever / knob is not required to open the door.

### Features and Specifications

#### Features

Adjustable bolt projection with locknut to prevent loosening.

#### Handing

Non-handed

#### Supplied

Fixing screws

Both 30mm and 90mm strikes supplied as standard

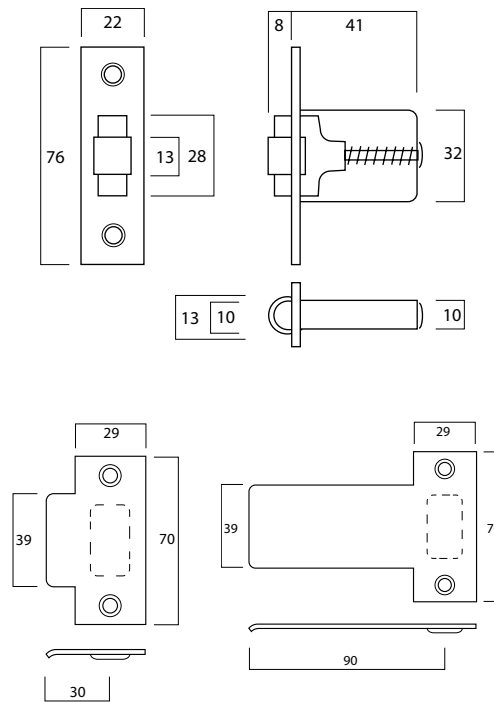

## 6260 Privacy Bolt

Finish	Packaging	Part Number
Polished Brass	Trade	6260PB
Polished Stainless Steel	Trade	6260PSS
Satin Stainless Steel	Trade	6260SSS

Suitable for through fixing of disabled turns and emergency indicating turns

### Features and Specifications

#### Features

Tubular privacy bolt

60 mm backset

Strike

Spindle

Fixing screws.

#### Handing

Non-handed

#### Supplied

Fixing screws

Strike

Latch



# Bolts and Latches

## 5260 Tubular Latch

Description	Part Number	Commercial / Residential	Function	Spindle Supplied
60MM PASSAGE LATCH SQUARE END FACE PLATE & T STRIKE- CHROME PLATE	5260/1SFTCP	Commercial	Passage	Yes
60MM PASSAGE LATCH SQUARE END FACE PLATE & T STRIKE- POLISHED BRASS	5260/1SFTPB	Commercial	Passage	Yes
60MM PASSAGE LATCH SQUARE END FACE PLATE & T STRIKE- BRUSHED SC	5260/1SFTSC	Commercial	Passage	Yes
60MM PASSAGE LATCH SQUARE END FACE PLATE & T STRIKE- SATIN CHROME PEARL	5260/1SFTSP	Commercial	Passage	Yes
60MM PASSAGE LATCH DRIVE IN WITH ROUND STRIKE	5260/1DIRCP	Residential	Passage	No
60MM PASSAGE LATCH SQUARE END FACE PLATE AND D STRIKE	5260/1SFDSP	Residential	Passage	No
60MM PASSAGE LATCH SQUARE END FACE PLATE AND D STRIKE	5260/1SFDSC	Residential	Passage	No
60MM PASSAGE LATCH SQUARE END FACE PLATE AND D STRIKE	5260/1SFDSP	Residential	Passage	No
60MM PRIVACY LATCH DRIVE IN WITH ROUND STRIKE	5260/2DIRCP	Residential	Privacy	No
60MM PRIVACY LATCH SQUARE END FACE PLATE AND D STRIKE	5260/2SFDSP	Residential	Privacy	No
60MM PRIVACY LATCH SQUARE END FACE PLATE AND D STRIKE	5260/2SFDSC	Residential	Privacy	No
60MM PRIVACY LATCH SQUARE END FACE PLATE AND D STRIKE	5260/2SFDSP	Residential	Privacy	No



Tubular latch designed for use with horizontal through fixing door furniture.

### Features and Specifications

#### Features

2 Hour Fire Rating  
60mm Backset

#### Handing

Non-handed

#### Supplied

Fixing screws  
Strike  
Latch

### Fire Rated

Lockwood 5260 Series latches has been successfully tested up to two hours (depending on type of doorset) on fire door assemblies in accordance with Australian standard As 1905. 1- 2005, Part 1: Fire Resistant Doorsets

# Bolts and Latches

## 5260 Tubular Latch Accessories

Description	Part Number	Commercial / Residential	Function	Spindle Supplied
5200 D STRIKE CHROME PLATE	5200/STRIKEDCP	Residential	Strike	No
5200 D STRIKE SATIN CHROME	5200/STRIKEDSC	Residential	Strike	No
5200 D STRIKE SATIN PEARL	5200/STRIKEDSP	Residential	Strike	No
5200 ROUND STRIKE CHROME PLATE	5200/STRIKERCP	Residential	Strike	No
5200 T STRIKE CHROME PLATE	5200/STRIKETCP	Commercial	Strike	No
5200 T STRIKE POLISHED BRASS	5200/STRIKETPB	Commercial	Strike	No
5200 T STRIKE BRUSHED SATIN CHROME PLATE	5200/STRIKETSC	Commercial	Strike	No
5200 T STRIKE SATIN PEARL	5200/STRIKETSP	Commercial	Strike	No

## 8530 Special Latch

Description	Finish	Packaging	Part Number
Double bevel latch	Satin Chrome	Trade	8530-305SC
Top latch adaptor plate	Satin Stainless Steel	Trade	SP8530-114SSS

A special purpose latch featuring a double bevel aluminium bronze bolt to be used in specialist applications. A comprehensive range of accessories are available for use with the 8530-305SC latch.

### Features and Specifications

#### Features

- Double bevel aluminium bronze bolt
- 4hr fire rated
- 60mm backset
- Supplied with fixing screws

#### Suitability

- Single push and pull doors
- Double push and pull doors.

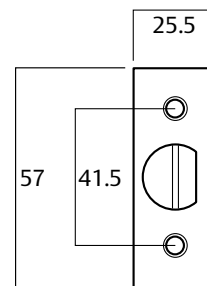
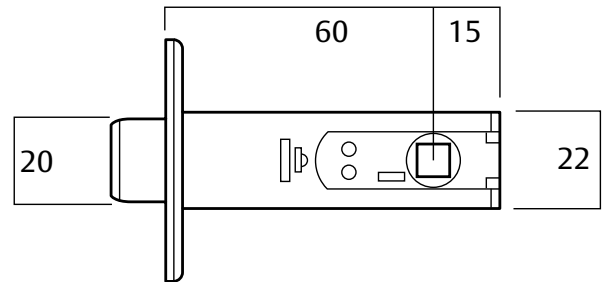

### Fire Rated

The Lockwood 8530 latch has been successfully tested to 4 hours on fire door assemblies in accordance with Australian Standards As 1905.1-2005, Part 1: Fire Resistant Doorsets



# Bolts and Latches

## 8530 Special Latch Strikes

Description	Finish	Packaging	Part Number
Single angle strike	Satin Chrome	Trade	SP8530-353SC
Double angle strike	Satin Chrome	Trade	SP8530-253SC
T strike	Satin Stainless Steel	Trade	SP8530-5053SSS

A range of strikes to be used with the 8530 Double Bevel latch in specialist applications.

### Features and Specifications

#### Features

SP8530-353SC and SP8530-253SC supplied with fixing screws.

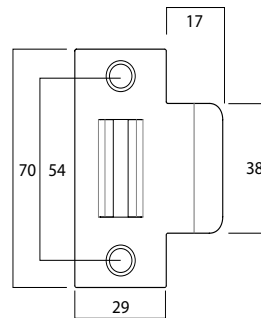
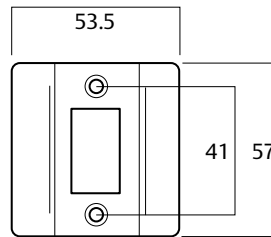
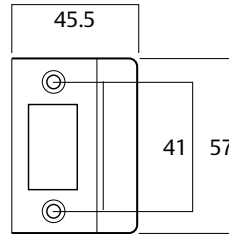

## 8530 Special Latch Turn Knob

Description	Finish	Packaging	Part Number
Turn Knob	Satin Chrome	Trade	SP8530-57SC
Spindle PK=20	Satin Chrome	Trade	SP8530-27

A solid brass turn knob to be used with the 8530 Double Bevel latch in specialist applications.

### Features and Specifications

#### Features

Solid brass  
Spindle included  
Supplied with fixing screws

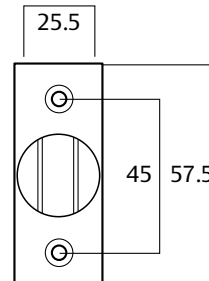

# Bolts and Latches

## Non Electric Strike

**Finish**      **Packaging**    **Part Number**

Satin Stainless Steel    Trade    107501-090

The Lockwood Non-Electric Strike is used with the 8530-305SC Double Bevel latch on E Core fire doors that require a push/pull function.

The profile of the Lockwood Non-Electric Strike has the same dimensions as a universal strike plate (70mm height x 29mm width and 55mm between centers of fixing holes). This allows the Lockwood Non-Electric Strike to be installed directly into a universal strike preparation with minor depth adjustment to the doorframe.

The body (depth 28mm) is cast stainless steel with the faceplate Satin Stainless in finish. The stainless steel keeper is held within the body by a single bronze pin and has a spring to return the keeper. A U-shaped rubber buffer is fitted to minimize impact shock and noise of the keeper.

### Features

#### Features

- Fire tested up to 4 hours
- Australian design and manufactured
- Full stainless steel keeper and body
- Corrosion resistant
- Easily installed
- Low maintenance

### Fire Rated



The Lockwood Non- Electric strike has been successfully tested to 4 hours on an E Core fire door at the CSIRO to Australian Standards AS 1530.4

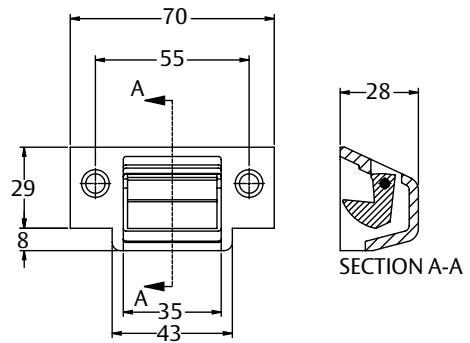

# Flush Pulls



The range of Lockwood Flush Pulls offer multiple solutions for flush mount door furniture.

## Application

The range of Lockwood Flush Pulls are suited to numerous applications which require the door furniture to be flush with the surface of the door.

## Product Details

<b>Finishes</b>	Satin Stainless Steel ( <b>SS</b> ) Polished Stainless Steel ( <b>PS</b> ) Chrome Plate ( <b>CP</b> ) Satin Chrome Pearl ( <b>SP</b> ) Polished Brass Plate ( <b>PBP</b> )
<b>Materials</b>	Zinc Stainless Steel

## Standards and Compliance



These products have been successfully tested in accordance with AS 2331-3.1: 2001. Neutral Salt Spray Test (NSS TEST).

# Flush Pulls

## L609

Dimensions	Finish	Packaging	Part Number
85 x 30mm	Chrome Plate	Display	L609CPDP
	Polished Brass Plate	Display	L609PBPD
	Satin Chrome Pearl	Display	L609SPDP

### Features and Specifications

- Zinc alloy cast flush pull
- Display packed, complete with fixing screws

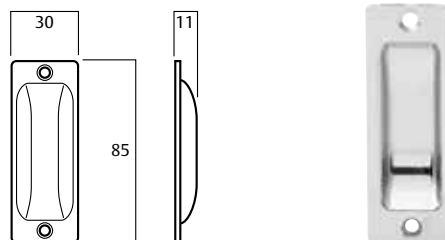

## L611

Dimensions	Finish	Packaging	Part Number
115 x 35mm	Chrome Plate	Display	L611CPDP
	Polished Brass Plate	Display	L611PBPD
	Satin Chrome Pearl	Display	L611SPDP

### Features and Specifications

- Zinc alloy cast flush pull
- Display packed, complete with fixing screws

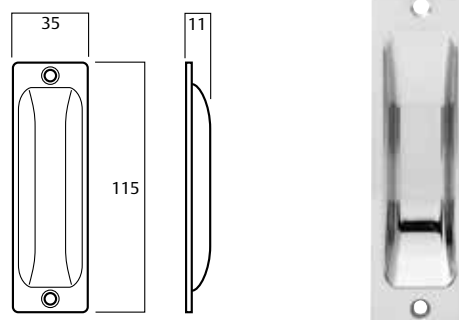

## L610

Dimensions	Finish	Packaging	Part Number
145 x 40mm	Chrome Plate	Display	L610CPDP
	Satin Chrome Pearl	Display	L610SPDP

### Features and Specifications

- Zinc alloy cast flush pull
- Display packed, complete with fixing screws

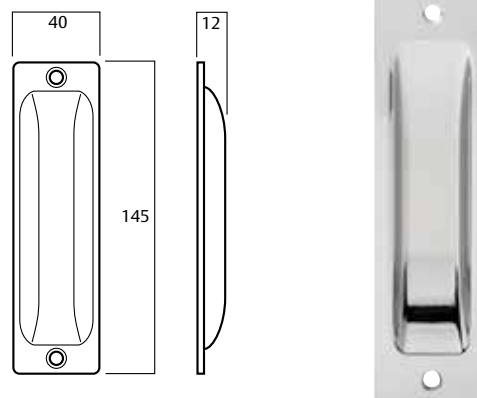

# Flush Pulls

## FP1-120

Dimensions	Finish	Packaging	Part Number
120 x 50mm	Satin Stainless Steel	Trade	FP1-120SS
	Polished Stainless Steel	Trade	FP1-120PS

### Features and Specifications

- Stainless steel flush pull
- Trade packed, complete with fixing screws

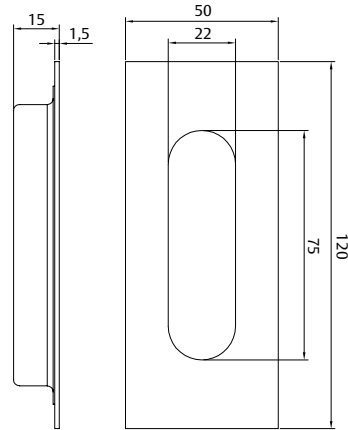

## FP1-150

Dimensions	Finish	Packaging	Part Number
150 x 50mm	Satin Stainless Steel	Trade	FP1-150SS
	Polished Stainless Steel	Trade	FP1-150PS

**Note:** Fixing screws included.

### Features and Specifications

- Stainless steel flush pull
- Trade packed, complete with fixing screws

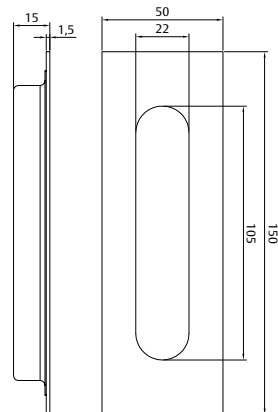

# Flush Pulls

## FP2-120

Dimensions	Finish	Packaging	Part Number
120 x 50mm	Satin Stainless Steel	Trade	FP2-120SS
	Polished Stainless Steel	Trade	FP2-120PS

### Features and Specifications

- Stainless steel flush pull
- Trade packed, complete with fixing screws

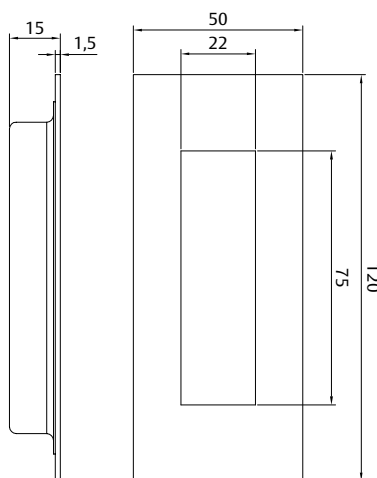

## FP2-150

Dimensions	Finish	Packaging	Part Number
150 x 50mm	Satin Stainless Steel	Trade	FP2-150SS
	Polished Stainless Steel	Trade	FP2-150PS

### Features and Specifications

- Stainless steel flush pull
- Trade packed, complete with fixing screws

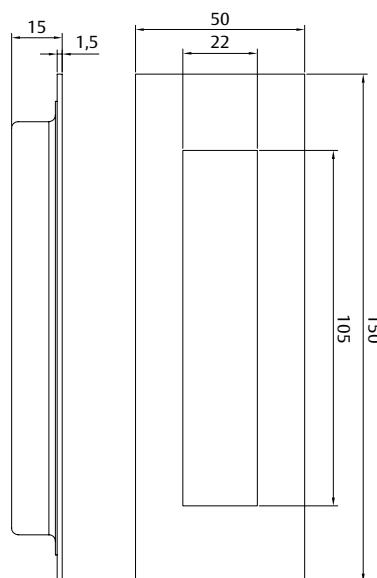

# Cupboard Handles



The range of Lockwood Cupboard Handles will bring a stylish finish to your cupboards. There are several styles in different finishes to ensure the right handle is available for your application.

## Application

The range of Lockwood Cupboard Handles are suitable for all cupboard doors.

### Product Details

<b>Door Thickness</b>	Up to 19mm
<b>Finishes</b>	Satin Stainless Steel (SS) Polished Stainless Steel (PS) Satin Chrome Pearl (SP)
<b>Materials</b>	Stainless Steel Brass
<b>Fixing</b>	Fixing screws included.

### Standards and Compliance



These products have been successfully tested in accordance with AS 2331-3.1: 2001. Neutral Salt Spray Test (NSS TEST).

# Cupboard Handles

## CH1-224

Dimensions	Finish	Packaging	Part Number
12x12x224(C-C) x35(H)mm	Satin Stainless Steel	Trade	CH1-224SS
	Polished Stainless Steel	Trade	CH1-224PS

**Note:** Fixing screws included.

### Features and Specifications

- Stainless steel cupboard handles
- Available in two finishes
- Trade packed, complete with fixing screws

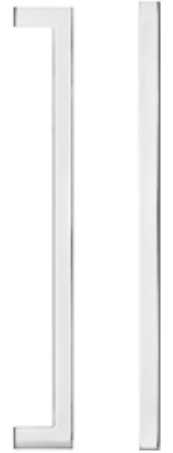
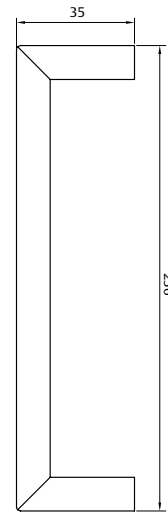

## CH2-224

Dimensions	Finish	Packaging	Part Number
Dia12x224(C-C) X288(L)X34(H) mm	Satin Stainless Steel	Trade	CH2-224SS
	Polished Stainless Steel	Trade	CH2-224PS

**Note:** Fixing screws included.

### Features and Specifications

- Stainless steel cupboard handles
- Available in two finishes
- Trade packed, complete with fixing screws

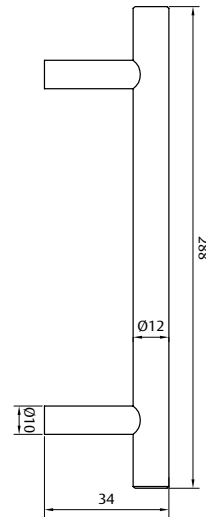

## CH3-224

Dimensions	Finish	Packaging	Part Number
Dia10x224(C-C) x35(H)mm	Satin Stainless Steel	Trade	CH3-224SS
	Polished Stainless Steel	Trade	CH3-224PS

**Note:** Fixing screws included.

### Features and Specifications

- Stainless steel cupboard handles
- Available in two finishes
- Trade packed, complete with fixing screws

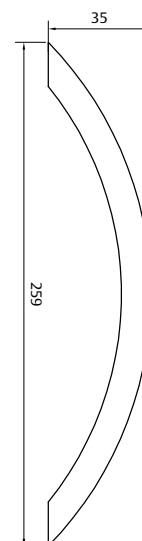



# Cupboard Handles

## L70

Product	Length	Finishes	Packaging	Part Number
L70	100mm	Satin Chrome Pearl	Display	L70SPDP

### Features and Specifications

- Extruded brass handle, concealed fixing
- Display packed, complete with fixing screws



## CK1-25

Dimensions	Finish	Packaging	Part Number
Dia25x30mm	Satin Stainless Steel	Trade	CK1-25SS
	Polished Stainless Steel	Trade	CK1-25PS

**Note:** Fixing screws included.

### Features and Specifications

- Stainless steel cupboard knob
- Available in two finishes
- Trade packed, complete with fixing screw

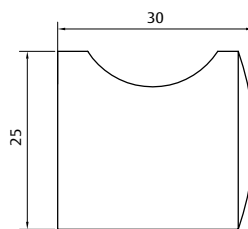

# Window Lock Accessories



The range of Lockwood Window Lock Accessories provide numerous solutions for ensuring that windows can be operated and secured safely with minimal fuss.

## Application

The Lockwood range of Window Lock Accessories are suitable to be installed on Double Hung and Casement windows. Wood screws are supplied as standard.

## Product Details

### Finishes

Chrome Plate (**CP**)  
Satin Chrome Pearl (**SP**)  
Polished Brass Plate (**PB**)  
Florentine Bronze (**FB**)

### Materials

Zinc  
Brass

## Standards and Compliance



These products have been successfully tested in accordance with AS 2331-3.1: 2001. Neutral Salt Spray Test (NSS TEST).

# Window Lock Accessories

## Sash Fastener

Finish	Packaging	Part Number
Chrome Plate	Display	L822CPDP
Satin Chrome Pearl	Display	L822SPDP
Florentine Bronze	Display	L822FBDP
Polished Brass Plate	Display	L822PBPD

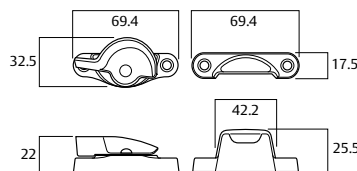

### Features and Specifications

- Designed for double hung windows
- Zinc alloy casting
- Individually display packed
- Complete with fixing screws



**Window Type**  
Double Hung.

## Casement Fastener

Finish	Packaging	Part Number
Chrome Plate	Display	L27CPDP

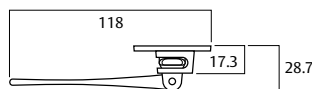

### Features and Specifications

- Designed for casement windows
- Zinc alloy casting
- Individually display packed
- Complete with fixing screw

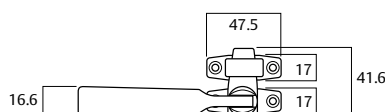

**Window Type**  
Casement.

# Window Lock Accessories

## Telescopic Stay

Finish	Packaging	Part Number
Chrome Plate	Display	L723CPDP

### Features and Specifications

- Designed for casement windows
- Maximum opening length of 225mm
- Zinc alloy castings
- Individually display packed
- Complete with fixing screws



**Window Type**  
Casement.

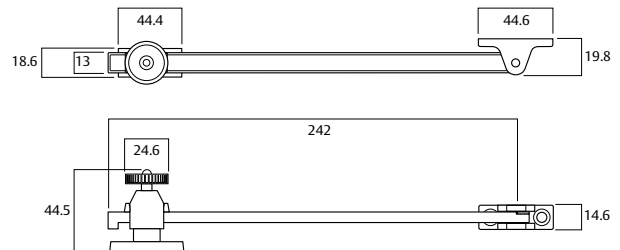

## Sash Lift

Finish	Packaging	Part Number
Chrome Plate	Display	L384-45CPDP
Polished Brass	Display	L384-45PBDP
Satin Chrome Pearl	Display	L384-45SPDP

### Features and Specifications

- Designed for double hung windows
- Extruded brass
- 2 sash lifts per display pack
- Complete with fixing screws



**Window Type**  
Double Hung.

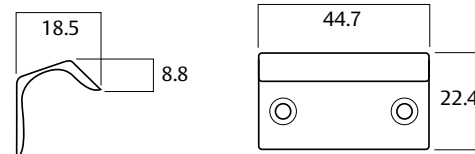



**ASSA ABLOY**

**Lockwood** is the leading brand in the Australian locking industry. With an established reputation for high quality products, this iconic brand provides a wide range of locking solutions to residential housing, commercial building and industrial application markets. Lockwood is supported by an extensive distribution and after-sales support network. Our customers include retailers, architects, trade and industrial personnel, locksmiths and security dealers.

**ASSA ABLOY** is the global leader in door opening solutions, dedicated to satisfying end-user needs for security, safety and convenience.

**ASSA ABLOY** is represented in all major regions, in both mature and emerging markets, with leading positions in Australia, Europe and North America.

**25YEAR  
MECHANICAL  
WARRANTY**

### **The Lockwood 25 Year Mechanical Warranty**

Our belief that we manufacture the finest premium products available in today's market place is backed by the Lockwood 25 Year Mechanical Warranty, ensuring that Lockwood continues to keep Australians safe by delivering security and peace of mind.

For warranty terms and conditions, please visit [www.lockweb.com.au](http://www.lockweb.com.au) or call **1300WARRANTY**

**ASSA ABLOY Australia Pty Ltd**  
235 Huntingdale Road  
Oakleigh, Victoria, 3166  
Australia

**1300 LOCK UP (1300 562 587)**  
[lockweb.com.au](http://lockweb.com.au)

**ASSA ABLOY New Zealand Ltd**  
6 Armstrong Road  
Albany, Auckland, 0632  
New Zealand

**[info.nz@assaabloy.com](mailto:info.nz@assaabloy.com)**  
**Telephone +64 9415 7111**  
**[assaabloy.co.nz](http://assaabloy.co.nz)**